

KALFIRE
FIREPLACES

Gi

User Instructions
BALANCED FLUE GAS SYSTEMS

KALFIRE

FIREPLACES

Balanced Flue Gas Systems Kalfire Gi

Gi105/59F, Gi110/55C, Gi115/55S
Gi105/79F, Gi110/75C, Gi115/75S
For gas type: G20, G25, G30 en G31

Version 12-2023

Contents

1	General information.....	5
1.1	Foreword.....	5
1.2	Pictograms.....	6
1.3	Warranty.....	7
1.4	Gi fireplace compatibility.....	8
2	Safety.....	10
2.1	Safety instructions for decorative elements (filling).....	10
2.2	Safety related to use.....	10
2.3	Three safety measures for the gas fire.....	13
3	Kalfire Gi functions.....	14
3.1	Manual functions.....	14
3.2	Programmable functions.....	14
4	Operating Kalfire Gi.....	17
4.1	Operation options.....	17
4.2	KalSense ring.....	17
4.3	Remote control.....	18
5	Kalfire Connected app.....	29
5.1	Installing the Kalfire Connected app.....	29
6	Maintenance.....	31
6.1	Maintenance.....	31
6.2	Door removal.....	33
6.3	Replacing batteries.....	36
6.4	Disassembly and disposal.....	37
7	Attachments.....	38
7.1	Troubleshooting.....	38
7.2	Product card – part 1 (in conformance with (EU) 2015/1186.....	40
	Appendix IV).....	40
7.3	Product card – part 2 (in conformance with (EU) 2015/1186 Appendix IV)...	41
7.4	Declaration of conformity.....	42
7.5	Configuration of the decorative elements.....	43

1 General information

The following sections provide general information about the gas fire:

- Foreword
- Pictograms
- Warranty
- Receipt and verification

1.1 Foreword

This user instruction has been written for the users of the gas fire. A separate Installation Manual accompanies this User Instructions. The user instructions should remain in the vicinity of the gas fire so that they are readily available for fireplace users.

The gas fire may only be installed by qualified technicians complying with all relevant national or local regulations. The current technology status, the provisions of the Building & Housing Inspectorate and the national and European regulations should be taken into account with regard to the installation work and the operation of the gas fire once fully connected.

Maintenance and repair work may only be carried out by authorized technical fitters.

Effective use

This gas fire has been designed as ambiance heating and has not been designed to be used as the principal heating unit for part of a house or throughout the house.

De gashaard met afstandsbediening mag uitsluitend gebruikt worden overeenkomstig met het ontwerpdoel en met inachtneming van de installatiehandleiding en gebruikersinstructies.

The gas fire and accompanying remote control may only be used in accordance with the reason it was designed and after review of the Installation Manual and user instructions.

Modifications of whatever nature can also affect the safety of the gas fire. Alterations can nullify the warranty and the technical testing and certification is no longer applicable.

If the gas fire is not installed correctly, all warranty and/or damage claims against Kalfire will be declared null and void. This gas fire has been tested and approved according to CE standard EN-613. Every gas fire that leaves the factory has been tested for technical and functional adherence to relevant quality standards in force.

This instruction is available in various languages on www.kalfire.com. All translated instructions have been translated from a Dutch instruction, which is the original document.

Disclaimer

All rights reserved. No part of this manual may be copied, distributed or translated into other languages, in full or in part, without the prior written permission of Kalfire. Kalfire reserves the right to make changes to the manual. Kalfire, however, cannot provide any warranty, implicitly or explicitly, for this manual. Any risk is fully for the account of the user.

Copyright © 2023 Kalfire B.V. Geloërveldweg 21, Belfeld, The Netherlands

1.2 Pictograms

The following pictograms are used in this manual;



IMPORTANT!

Warning for explosive material. Mitigate the risk of an explosion by carrying out these instructions carefully in the vicinity of explosive materials.



DANGER!

Warning for flammable material. Follow instructions to ensure that the possibility of fire thanks to the sudden ignition of flammable materials is prevented.



WARNING

General warning. Mitigate the risk of injury by carrying out the instructions carefully.

**CAREFUL!**

General warning. Mitigate the risk of material damage by following the instructions diligently.

1.3 Warranty

Kalfire products are manufactured with meticulous precision from premium materials. Despite this, should an error or defect become apparent, Kalfire will provide warranty coverage according to the following provisions.

Warranty conditions:

1. The warranty period for Kalfire gas appliances amounts to two years from the procurement date, that must be clearly legible on the proof of purchase.
2. The warranty period of 2 years does not apply to discoloration of the varnish on the flat or design; in this case a warranty period of 1 year applies.
3. Glass and rubber seals are excluded from the warranty.
4. Physical and chemical influences from outside during transport, storage or installation are not covered by the guarantee.
5. The gas fire must be installed by a technician approved by Kalfire according to this Installation Manual and in compliance with all relevant national and regional standards in force.
6. Kalfire assumes no responsibility for errors or defects related to the installation of the gas fire. Placing of the appliance, the quality and material choice of the finished product and a check as to the correct operation of the concentric flue duct system are the responsibility of the fireplace dealer approved by Kalfire.
7. The warranty covers no right whatsoever to compensation in the event that the appliance cannot be used.
8. Should disruption occur within the warranty period caused by a manufacturing error or material defect, Kalfire will deliver the components needed for repair to the installer of the gas fire, without paying compensation for dismantling or assembly.
9. Renewing or replacing components that fall under the scope of the guarantee do not extend the duration of the warranty.
10. Should the Kalfire-approved installer be unable to rectify the problem covered by the warranty, then he is entitled upon his own express desire to

request Kalfire to assume responsibility for doing so (only valid in the Benelux, Germany, France and the United Kingdom).

11. Verification or repair of an entire gas fire or parts thereof can only take place by appointment, after prior consultation between Kalfire and the installer approved by Kalfire.
12. A dated proof of purchase must be presented to Kalfire should a possible home repair service (only available in the Benelux, Germany, France and the United Kingdom) be carried out within the warranty period.
13. In the event of home repair service outside the warranty period, material costs, working hours and call-out charges will apply.

The warranty is not applicable in the following circumstances:

1. If the warranty provisions have not been complied with, in part or in full.
2. If alterations to the appliance have been brought about without Kalfire's written permission to do so.
3. If the appliance passes into new ownership.
4. If the appliance has not been fitted according to the Installation Manual and/or has not been used according to the user instructions.
5. Should deviation from the Kalfire specifications have occurred in any way or form during installation of the concentric flue duct system.
6. Should deviation from the Kalfire specifications have occurred in any way or form during configuration of the decorative elements, including possible ceramic wood logs on the burner bed.
7. Damage attributable to external causes (shocks, lightning, falling, flooding or overheating of the appliance) during transport, storage or installation.
8. Should the appliance be impacted by neglect, improper use and/or gross negligence.
9. If the repair or delivery of individual parts be carried out by another manufacturer or by a professional technical fitter who has not been approved by Kalfire.

1.4 Gi fireplace compatibility

Besides the remote control, you can also operate the fireplace with an external device (e.g. tablet, phone). This connection can be established by connecting the Gi fireplace directly to the router with a UTP cable or through a wireless Wi-Fi connection. In case the fireplace is connected wirelessly to the home router, in some cases the WiFi connection may not work properly. This may be caused by insufficient coverage (signal) of the WiFi network or because connected devices (u.w. phone, tablet, router) are not compatible. Connection via a UTP cable is therefore always preferred.



The Gi haard and your external device must be connected to the same router (via the same network). The Wi-Fi signal can be checked beforehand and improved if necessary. Due to the great diversity of devices (smartphones/tablets), the compatibility of the devices can unfortunately not be checked in advance. Compatibility will only become clear after installation of the interface. Kalfire accepts no liability for the failure of the Gi fireplace to function properly or at all due to causes described here.

2 Safety

2.1 Safety instructions for decorative elements (filling)



FIRE DANGER!

The fireplace filling must be placed as prescribed. It is not permitted to change the quantity or configuration of the filling. A change may cause a fire hazard.



WARNING!

The ignition/ionization pin must remain uncovered, pay attention to this when placing the filling. Careless decoration of the gas fire can cause incorrect ignition and/or a dangerous situation.



WARNING!

If the fireplace is supplied with Natural Spark Generator, do not remove the plastic filler cap during installation. The plastic filler cap is required to ensure proper operation. The filler cap is then covered with a piece of ceramic log when installing the fireplace filler.



CAUTION!

Small hair cracks may appear in the ceramic logs during use of the fireplace, these do not adversely affect the operation or flame pattern of the fireplace. Hairline cracks are not covered by the guarantee.



CAUTION!

During use, the metal interior of the fireplace will expand. This may cause damage or unevenness in the lacquer layer of the metal. These can be repaired with the spray can supplied.

2.2 Safety related to use

There are risks attached to using a gas fire. The temperature of all visible parts of the gas fire can rise steeply and there is a risk of fire or combustion. Be sure that the following safety precautions have been taken:

**WARNING!**

The gas fire must not be started if the front and/or side window is damaged or broken.

**WARNING!**

After installation of the gas fire, the visible parts of the appliance (including the glass surface) are considered as part of the active zone.

Especially the glass can get extremely hot!

Children and dependents are to stay clear of the burning gas fire.

**DANGER!**

Make sure that flammable materials such as curtains and furniture are at least 100 cm from the fireplace. If a fireguard is used, this distance must be at least 40 cm.

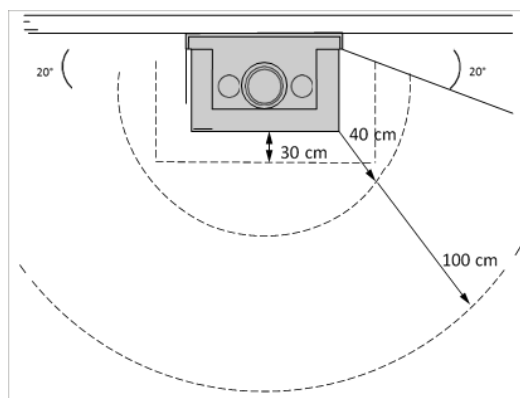
**WARNING!**

Should the floor in front of the fireplace consist of combustible material and the distance from the underside of the combustion chamber to the floor be smaller than 10 cm, a heat-resistant fireguard floor plate larger than 30 cm or a stone should be placed.

Danger of burning

**WARNING!**

Do not touch the appliance! The gas fire is hot when switched on or just switched off. Ensure extra safety precautions and safety measures if less able-bodied persons, elderly people and/or children have access to the fireplace. Only the remote control can be used without fear of danger due to combustion.

Danger caused by fumes or gas leaks**IMPORTANT!**

Fumes and/or gas leaks can cause life threatening situations. Fumes can be the cause of carbon monoxide poisoning and gas leaks are an explosion risk.

If you notice fumes or gas, take the following precautions:

1. Switch off the gas fire.
2. Close the main gas valve.
3. Open windows and doors.
4. Advise an approved installer of the issue.

**IMPORTANT!**

Should damage occur, close the gas valve. Do not use the gas fire if a glass panel is cracked, is not in place or incorrectly mounted.

**IMPORTANT!**

The gas fire needs a permanent power supply. Interrupting the power supply can impact safety precautions.

The risk of discoloration



CAREFUL!

After the convection system of the fireplace has been heated, air particles, cigarette smoke, candles and oil lamps can cause discoloration of walls and ceilings. Ensure sufficient ventilation in the room in which the fireplace is installed.



CAREFUL!

Applying tape to the fireplace is at your own risk, paint damage caused by taping is outside the manufacturer's warranty.

2.3 Three safety measures for the gas fire

The flame is detected due to electronic ionization measurement. If the gas fire does not detect a flame during the start-up phase, the gas supply is interrupted for one minute. A new ignition attempt follows automatically. To interrupt automatic ignition attempts immediately; Press the on/off button (max 2 sec.) to switch the fire off immediately.

A 24-hour security system

If no flame is detected after three automatic ignition attempts (for gas types G20, G25), a blocking occurs. For gas types G30 and G31, this blocking occurs after one ignition attempt. This lockout can be manually unlocked twice with the remote control. If no flame is detected after these two manual releases, a 24-hour lock-out will follow. You can then not use the gas fire for 24 hours.

Pressure relief device

The gas fire is equipped with an overpressure safety device to minimise risks. Should an explosive ignition occur, the top window will open forward to reduce pressure.

3 Kalfire Gi functions

The Kalfire Gi distinguishes between programmable and manual functions.

3.1 Manual functions

Manual functions are functions with fixed parameters that you cannot adjust yourself.

Increase flame height / Decrease flame height

The height of the flames can be selected using the Flame Height Up and Flame Height Down function. All three burners (left, center and right) are controlled simultaneously, creating a calm flame pattern at the desired height.

Comfort function

In comfort mode, you choose a certain average flame height and associated savings in gas consumption. The lower the average flame height the greater the savings. As the three different burners (left, right and center) are controlled separately, the flame pattern remains full and dynamic even in the lower settings with little gas consumption.

Ember Glow

The EmberGlow function that comes standard with every Gi fireplace simulates the red glow bed inside the fireplace, under the logs. Depending on the selected setting, the glow bed is more or less intense. The glow bed can be switched on even when the fireplace is not burning. Thus, even when the flames are extinguished, it provides an atmospheric glow on the fireplace floor.

Natural Spark Generator (option)

An optional NSG module can be chosen. This Natural Spark Generator ensures a continuous flow of natural-looking sparks that dance completely randomly above the flames. Depending on the selected setting, these are more or fewer sparks.

3.2 Programmable functions

Programmable functions can be programmed via the ConnectedApp entirely to your own preferences. If this does not happen, the factory settings apply.

**ATTENTION!**

For programmable functions (which are mostly temperature-controlled), it is important to place the remote control in a place where you want the desired temperature to be reached. The temperature sensor is inside the remote control.

Thermostat function

The thermostat function of the Kalfire Gi can be used to quickly heat the room in which the fireplace is set up. After all, it is not always necessary to heat the entire house or turn on the underfloor heating. Via the app, the desired end temperature can be specified in thermostat mode. The fireplace does the rest. If the desired temperature is reached, the fireplace turns off. When the temperature has dropped 1.5 degrees below the desired end temperature, the fireplace comes back on.

Factory setting thermostat function: end temperature: 21°C

**CAUTION!**

After going through the start-up cycle, the fireplace takes over the last settings used. If this is the thermostat function and the temperature in the room is higher or equal to the selected end temperature, the fireplace will switch off after completing the start-up cycle.

Comfort+ Function

Determine the maximum temperature rise and the time it should take the stove to reach this temperature. Also thanks to the three separately controlled gas valves, the flame image remains lively and beautiful. Adjustable via the ConnectedApp.

Factory setting Comfort+: end temperature: 21°C, time: 240 minutes

Moods

With the Moods function, different functions can be recorded together. For example, if the Comfort+ function in combination with setting 3 of the NSG and setting 4 of the EmberGlow function is your favourite setting, you can record this in your personal Mood. Programming your own Moods is only possible via the Kalfire ConnectedApp. Via this app, up to 10 different Moods can be programmed. Then, one push of the button is enough to activate the desired mood. With the remote control, 3 Moods can be controlled. If no

personal moods are programmed via the ConnectedApp, the factory settings apply.

Factory settings Moods:

Mood 1: Lazy

Comfort+: end temperature: 25°C, time: 240 minutes

EmberGlow: setting 2

Natural Spark Generator: setting 2

KalSense ring colour: white

Mood 2: Comfort

Comfort: setting 4

EmberGlow: setting 3

KalSense ring colour: red

Mood 3: Show-off

Flame height: setting 5

EmberGlow: setting 6

Natural Spark Generator: setting 5

Colour of KalSense ring: blue

4 Operating Kalfire Gi

4.1 Operation options

Operation of the fireplace can be done using either the Kalfire remote control or the Kalfire Connected app. The Kalfire Connected app offers more and more extensive operating options. This app can be downloaded for free in the Apple and Android app store respectively. The remote control comes standard with the fireplace.

4.2 KalSense ring

The patented KalSense ring located directly behind the glass at the front of the fireplace provides instant feedback on operating actions.

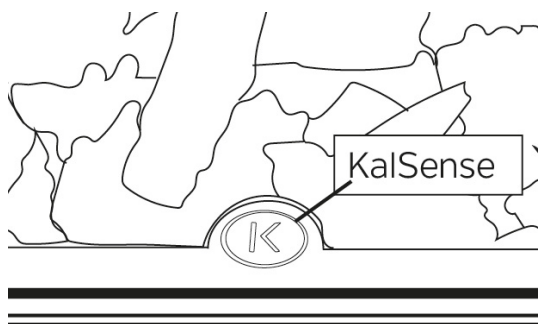

The ring indicates the status of the fireplace by means of colour, tessellation and/or flashing. For example, if the EmberGlow function is activated with the remote control or via the app, the ring briefly lights up orange and then goes out again.

The 9 boxes (LED lights) into which the ring is divided indicate the level of a particular function. The example below shows the fireplace's "flame height up" function, which consists of 5 levels. The higher the level, the more LEDs in the KalSense ring light up brightly. In the KalfireConnected app, the KalSense ring is also displayed on the screen. This corresponds to the KalSense ring in the fireplace.

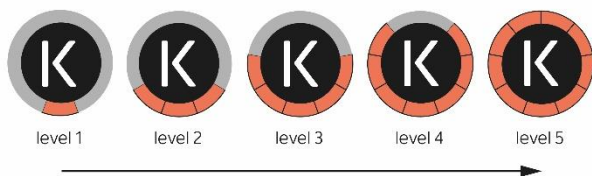

4.3 Remote control

The remote control buttons are linked to a specific function of the fireplace. The remote control changes the current setting of the fireplace, but does not provide feedback itself. When operated with the remote control, the KalSense ring in the fireplace (centre front) provides feedback.



CAUTION!

The remote control contains a temperature sensor and should be in the room where the fireplace is set up at all times, at least within 10 meters of the fireplace.

We recommend that you place the remote control near where you find yourself. This is because the temperature sensor in the remote control is necessary for the operation of the programmable functions.

4.3.1 Placing the battery

Insert the supplied battery into the remote control.

- Grasp the remote control on-the-head and turn it over.
- Place your thumb as shown below.
- Press the back lightly with your thumb and slide the cover upwards at the same time.



- Insert the battery (1 x AAA)
- Replace the cover in reverse order.

Bluetooth remote control pairing

The remote control should be paired with the fireplace at all times. The remote control is paired with the fireplace at the factory. If the batteries are inserted in the remote control, automatic pairing will take place.

You simply check whether the fireplace is paired by operating button 8 (hybrid LED function) on the remote control (see image below). If the glow bed in the fireplace lights up (even when the fireplace is not lit), the remote control is paired. With each press of the button, the glow bed's light intensity increases.

If the remote control is not paired, follow the instruction below.

Pairing:

To pair the remote control with the fireplace, both the communication board and the remote control must be activated. The communication board is located at the front of the fireplace and is accessible through the 7mm air gap (after installation).

- The green LED light on the board flashes.
- Briefly (2-5 sec), until the KalSense ring turns blue) press the reset button on the communication board. The communication board is located at the front of the fireplace and can be reached through the 7mm air gap (also after installation). Use a plastic/wood (**not iron!**) stick with a blunt tip.

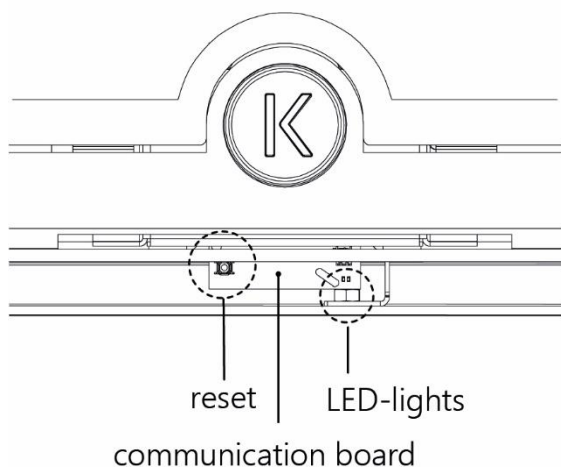

- Then (within 30 seconds), press the key combination below on the remote control to activate the synchronisation mode.



Pairing remote control on

The red LED-light on the left top of the remote control starts to blink.

- Release the buttons.

If the green LED light on the communication board is continuously lit and the red LED light on the remote control is no longer lit, the remote control has been successfully paired.



CAUTION!

Synchronisation is broken in the following cases:

- The remote control is more than 10 metres away from the fireplace.
- The batteries are removed from the remote control (e.g. to replace them).
- There is a power failure and/or failure of the communication board.

In all cases, synchronisation will automatically recover if the described situations are restored.

4.3.2. Remote control and symbols

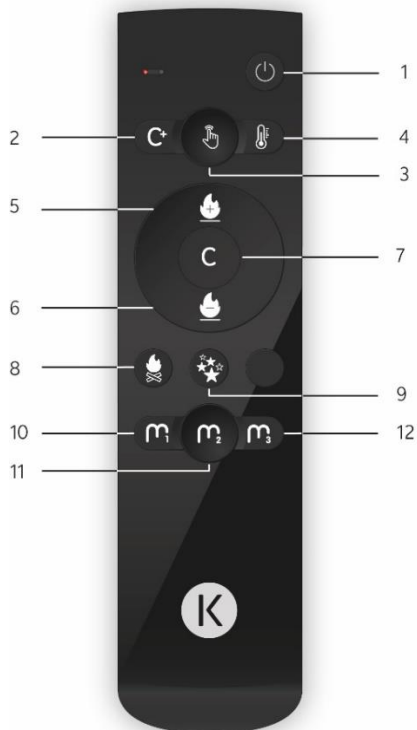

1. Fireplace on/off
2. Comfort+ function
3. Manual control
4. Thermostat function
5. Increase flame height
6. Reduce flame height
7. Comfort functie
8. EmberGlow (hybride functie)
9. Natural Spark Generator

**CAUTION!**

Change in the flame pattern after selecting a certain function almost always occurs with some delay. Depending on the function selected, this delay may be longer or shorter. The fireplace needs some time to measure the temperature (in some cases), calculate the correct set points and control the three gas valves.

**Fireplace on**

Press and hold the "fireplace on/off" button until the KalSense ring "fills up", then immediately release the button. The stove goes through the start-up cycle. During the start-up cycle, the KalSense ring flashes orange. The start-up cycle is complete when the KalSense ring lights up white briefly and then goes out.

**CAUTION!**

The entire start-up cycle takes several minutes (the fire goes through a safety protocol, among other things, during the start-up cycle).



Switching on the fire / start-up cycle

If the on/off button has been held too long or too short, the KalSense ring lights up briefly in red.

Restart the fireplace.

**CAUTION!**

During the start-up cycle, you cannot operate the various functions of the fireplace. However, you can abort the start-up cycle using the on/off button.



LET OP!

You should wait at least 3 minutes after aborting the start-up cycle before restarting the fireplace.

If the stove interrupts the start-up cycle for technical reasons or if the stove goes out after completing the start-up cycle, this may have several causes. Check Annex 1 for possible solutions.

Switching off the fireplace

From run mode (the stove is on): press button 1 x (do not hold) to switch off the stove. The KalSense ring lights up briefly.



Comfort + function

Moves to the last used comfort plus setting. Using the remote control, the Comfort+ function can be activated and deactivated. After activating the Comfort+ function, the KalSense lights up briefly and then goes out again.

KalSense feedback: green

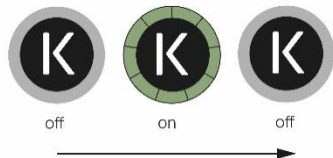

From Comfort+ function, the following functions (buttons) cannot be activated:

- Increase flame height (5)
- Reduce flame height (6)
- Comfort function (7)

The KalSense ring will light up red briefly each time you try to operate one of the functions.



Thermostat function

Moves to the last thermostat setting selected. Using the remote control, the thermostat function can be activated and deactivated. After activating the thermostat function, the KalSense lights up briefly and then goes out again.

KalSense feedback: turquoise

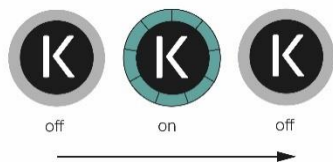

From Thermostat function, the following functions (buttons) cannot be activated:

- Increase flame height (5)
- Reduce flame height (6)
- Comfort function (7)

The KalSense ring will light up red briefly each time you try to operate one of the functions.



CAUTION!

If the desired end temperature has already been reached, the stove will switch off immediately after completing the start-up cycle. You can switch the stove on again by pressing button 3 "Manual operation".



Mood 1,2 and 3

Pre-programmed moods (ex-factory or self-set via APP). Using the remote control, 3 Moods can be activated and deactivated. After activating Moods function, the KalSense lights up briefly and then goes out again.

KalSense feedback:

Mood1: white

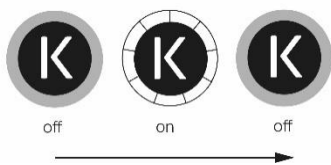

Mood2: red

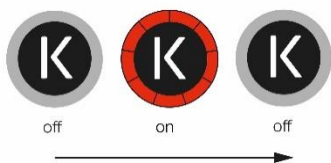

Mood 3: blue

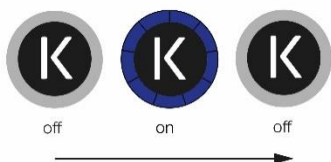

From the Mood functions, the following functions (buttons) cannot be activated:

- Increase flame height (5)
- Reduce flame height (6)
- Comfort function (7)
- EmberGlow (8)
- Natural Spark Generator (option) (9)

The KalSense ring will briefly light up red each time you try to operate one of the functions.



Manual operation

From the programmed modes (Comfort+, thermostat function and Moods) return to manual operation. After activating the Manual function, the KalSense lights up briefly and then goes out again.

KalSense feedback: white

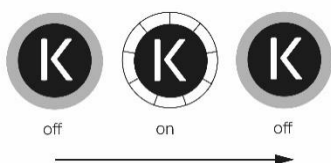

Increase flame height

Increase flame height by briefly pressing the button each time. Positions 1 to 5. Position 1: only middle burner on at low setting, position 2: 3 burners at low setting, position 3, position 4, position 5: 3 burners at high setting. After activating the buttons, the KalSense lights up briefly and then goes out again. Continuing to press from position 5 has no effect; the stove continues to burn at high setting. To lower the flames from position 5, use button 6 "lower flame height".

KalSense feedback: orange

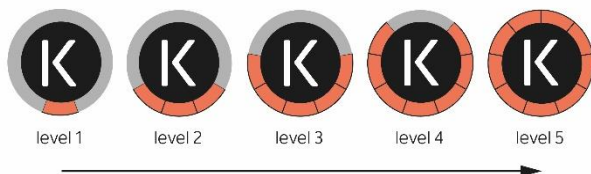



Reduce flame height

Reduce flame height, by briefly pressing the button each time. Position 5 to 1. position 5: 3 burners on high, position 4, position 3, position 2: 3 burners on low, position 1: only middle burner on low. After activating the buttons, the KalSense lights up briefly and then goes out again. Continuing to press from position 1 has no effect; the stove remains on low setting. To raise the flames from position 1, use button 5 "increase flame height".

KalSense feedback: orange

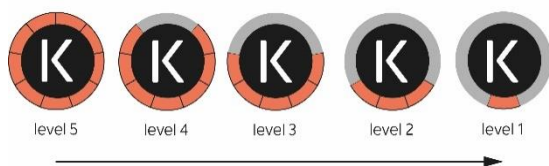

C

Comfort

Comfort setting: gas and heat savings thanks to modulating flame height.

Position 1: three burners modulate at the highest setting.

Position 2 and 3, the average flame height of the three modulating burners gets lower each time. Position 4: only the middle burner burns, modulating, at high setting.

Position 5: only the middle burner burns at the lowest setting. The greatest savings take place at this setting.

After activating the buttons, the KalSense lights up briefly and then goes out again.

KalSense feedback: green

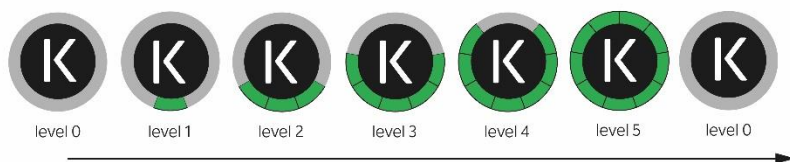



Hybrid-LED function/Ember Glow

In run mode (the fireplace is on): each press of the button takes you to the next level in light intensity, with setting 6 being the shuffle/flicker mode.

In off mode (the fireplace is off): press the hybrid button and only the hybrid lights will come on, then with each press of the same button you go to the next level. Mode 6 is the shuffle/flicker mode.

KalSense feedback: orange

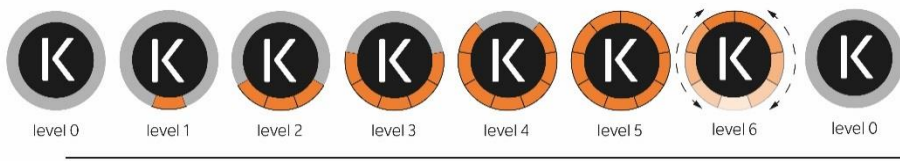

Natural Spark Generator (optional)

Switch on NSG. The fire continuously generates sparks at random times. The average amount of sparks depends on the selected setting. The higher the setting, the more sparks.

By continuing to press the button you move up (position 0 to 5) through the programme. From position 5 the NSG function switches to position 0. At position 0 the NSG function is switched off.

KalSense feedback: yellow

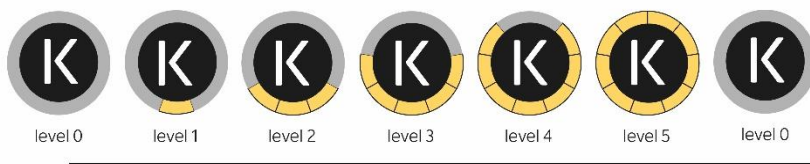

5 Kalfire Connected app

The Kalfire Connected app offers more and more extensive features than the remote control. Besides controlling the various functions, the temperature can be read and programmed for the thermostat and Comfort+ function via this app. Furthermore, 10 Moods can be programmed.

Multiple fireplaces can be added in the app. It is easy to switch between the different fireplaces.

5.1 Installing the Kalfire Connected app

Before installing the Kalfire Connected app, check:

- whether you are on the same WiFi network to which the fireplace is connected (The app must be connected to the fireplace via the WiFi network via a 2.4GHz WIFI network).
- Whether you have Bluetooth enabled

Download the Kalfire Connected app via Apple's appstore or Android's Playstore. Search for: Kalfire Connected App.

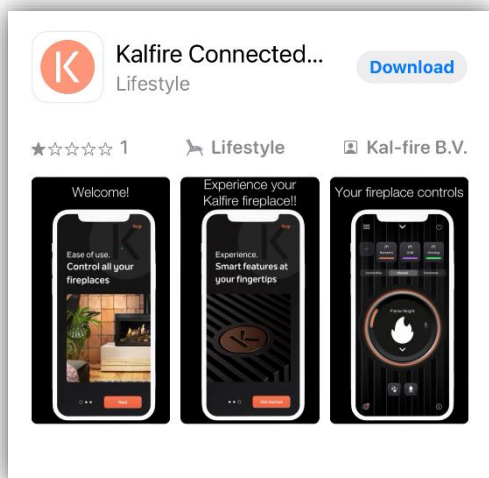

- Install the ap
- Download the app and follow the on-screen instructions
- Create an account



If you create an account, you will have access to all functionalities of the fireplace (which you can control via the KalfireConnected app). It also allows your dealer to read out technical parameters in case of service or maintenance.

If you have completed the one-time registration steps, you can use the KalfireConnected app.

6 Maintenance

6.1 Maintenance

Frequency of maintenance

The gas fire should be inspected at least once a year for optimal, sustainable and safe operation. If the fireplace is linked to the KalfireConnected app, various parameters can be read out during this inspection and any preventive maintenance can be carried out.

Defects on the gas fire should be remedied immediately. Ask your dealer about the possibilities of a maintenance contract.

Before and during the heating season

After some time, deposits may form on the inside of the glass. This can be removed with a damp cloth or non-scratch cleaning agent (ceramic glass cleaner). Do not use corrosive or abrasive agents to clean the fireplace. Paint damage is not covered by the guarantee. Minor damage can be touched up with heat-resistant lacquer. Paint is available from your Kalfire dealer.

6.1.1. Cleaning the (standard) ceramic windows.



WARNING

Different cleaning instructions apply for antireflective glass.

The gas fire glass can become dirty when the fireplace is burning, but also when being taken into use. Potential causes can be: Smoking materials in the fireplace (especially in the beginning), air contamination, quality of the type of gas etc.

Requirements :

- Filth and stains on the glass must be removed immediately.
- Never turn on the fireplace when it has filth or stains on the glass. This can lead to permanent and non-removable contamination.
- Clean the glass after the first use of the fireplace and clean the glass regularly in the initial period.
- Use scratch-free cleaning substances only.

6.1.2 Cleaning instructions anti-reflective glass

The gas fire glass can become dirty when the fireplace is burning, but also when being taken into use. Potential causes can be:

Smoking materials in the fireplace (especially in the beginning), air contamination, quality of the type of gas etc.

Anti-reflective glass is polished ceramic glass to which a number of metal oxide coatings have been applied that reduce the reflection to less than 1%. To prevent damage to these coatings, it

is important that you carefully comply with the following cleaning instructions. A blue/purple discolouration can become visible on the anti-reflective glass, as a result of using the gas fire.

Requirements:

- Filth or stains on the glass must be removed immediately.
- Never turn on the fireplace if the glass is filthy or stained. This can lead to permanent and non-removable contamination.
- Clean the glass after the first use of the fireplace and clean the glass regularly in the initial period.
- Wear (rubber) gloves when cleaning the glass; fingerprints are particularly noticeable on antireflective glass.
- Use water and a soft cotton cloth, chamois leather or a microfibre cloth.
- Use neutral glass detergent only: water solution with neutral or light alkaline detergent without additives or abrasive substances. The acceptable share of ammonia and solvents that are organically soluble in water must be smaller than 5%.
- Carefully clean the glass: use sufficient moisture, avoid pressure and rub the substance from top to bottom, to prevent cleaning detergent to remain on the glass.
- Continuously dry the glass completely using the cloth.

When using a vacuum lifter to remove the door, the suction cup rubber must be clean in order to prevent damage to the coating.



WARNING!

The table below lists the types of products never to be used when cleaning the anti-reflective glass:

Never use the products below:	The glass coating can be damaged by :
toilet cleaners	alkaline detergents or detergents with high levels of ammonia
hydrochloric acid	acids
bleach domestos	chlorine or sodium hypochlorite detergents
benzene, hexane or petroleum-based solvents	solvents
scouring powders, abrasive materials, steel wool, scrubbing or scouring pads, scrapers, razor blades, paper, ceramic stove cleaners	aggressive cleaning materials

6.2 Door removal

6.2.1 Door dismantling and assembly (corner and three-sided appliances)



WARNING

Wear (rubber) gloves to prevent stains on the glass.

Step 1: To unlock the door, pull the handles under the hood towards you and up.

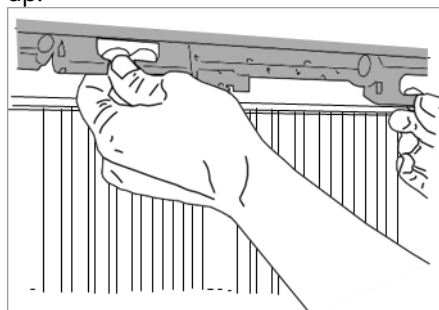

Step 2: Push the metal cover strip in left or right.

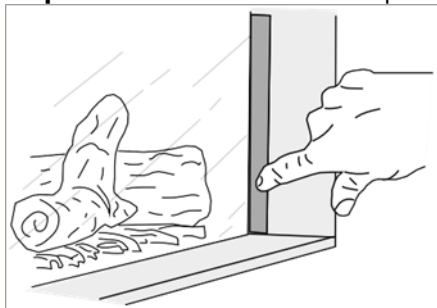

Step 3: Next, grip the door by the designated handles. Slightly lift the door with glass window out of the rabbet, move the entire door slightly to the left or right (corner fireplace) and carefully lift it entirely out of the fireplace. In a three-sided appliance the door will fall forward slightly and you will be able to lift it straight out of the rabbet.

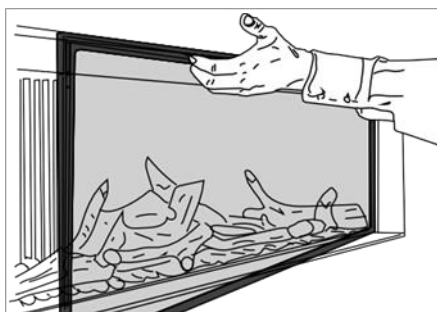

Putting the door back in place

To put the door back in place, follow the steps described in step 3 in reverse order. Lock the door by moving the handles down. Twist the metal cover strips (step 1) back into its original position by using the protruding lip at the upper side of the strip.

6.2.2 Door dismantling and assembly (front models)



WARNING

Wear (rubber) gloves to prevent stains on the glass.

Step 1: Move the metal cover strips up from the upper side.

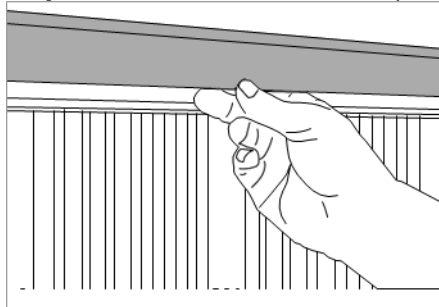

Step 2: To unlock the door, pull the handles that are placed under the hood towards you and up.

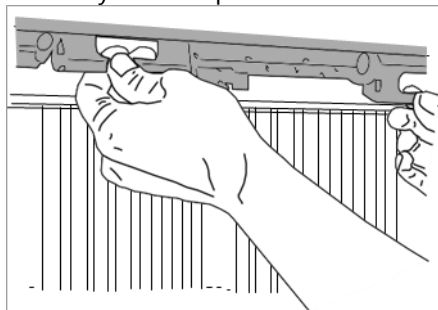

Step 3: Push the metal cover strip in left and right.

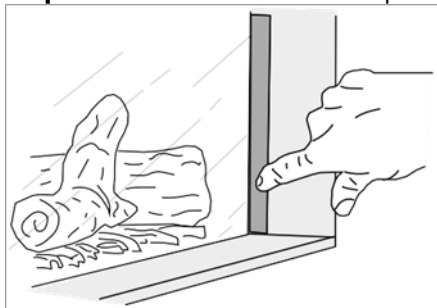

Step 4: Next, grip the door by the designated handles. Slightly lift the door with glass window out of the rabbet and carefully remove it from the fireplace.

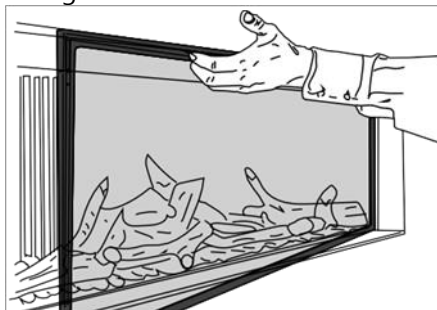

Putting the door back in place

To put the door back in place, follow the steps described in step 4 in reverse order. Lock the door by moving the handles down. Twist the metal cover strips (step 3) back in its original position, by using the overlapping edge on the upper side of the strip and fold the metal cover strip down.

6.3 Replacing batteries

Indien het rode ledlampje rechtsboven op de afstandsbediening niet meer oplicht indien u op één van de knoppen drukt, moet de batterij vervangen worden.

Replace the battery in the remote control as follows:

- Grasp the remote control on-the-head and turn it over.
- Place your thumb as shown below.

- Press the back lightly with your thumb and slide the cover upwards at the same time.

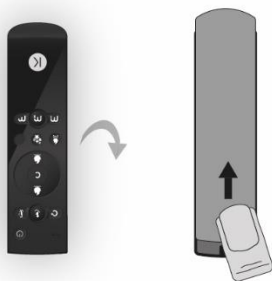

- Replace the battery into the remote control (1 x AAA)
- Replace the cover in reverse order.

6.4 Disassembly and disposal

Dismantle the device at the end of its service life according to local laws and regulations.

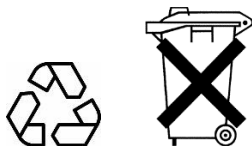

Remove the battery from the remote control. Return used batteries to a disposal point.



CAUTION!

The windows of the gas fire are made of ceramic glass and must not be disposed of in the bottle bank.

7 Attachments

7.1 Troubleshooting

Start-up phase

Problem: The fireplace does not respond to the remote control.

Solution:

- Check whether the remote control is synchronised with the fireplace. This can easily be done by pressing button 8 (hybrid LED function, see section 2.3) on the remote control. If the glow bed in the fireplace lights up (even when the fireplace is not lit), the remote control is paired.
or:
- Check whether the green LED light on the communication board is continuously lit green. If yes, the fireplace is paired with the remote control. If the LED flashes green, the remote control and fireplace are not paired and must be synchronised. The communication board is located at the front of the fireplace and is accessible through the 7mm air gap (after installation).
- Pair the fireplace with the remote control (see section- 4.3)
- Check whether there are batteries in the remote control and/or replace the batteries.

Problem: The fireplace itself interrupts the start-up cycle. If after three automatic ignition attempts (for gas types G20, G25) no flame is detected a blockage follows. With gas types G30, G31 this blocking follows after one ignition attempt. The KalSense ring flashes red. This blocking can be manually unlocked twice with the remote control. If no flame is detected after these two manual releases, a 24-hour lockout follows. You can then not use the gas fire for 24 hours.

Solution:

You can manually unlock the fireplace twice by pressing the on/off button briefly (<2 sec) from fault code mode (the KalSense flashes red). If the KalSense lights up green, you can try to switch the fireplace on again.
Contact the dealer if the reset fails and the fireplace falls into lock-down.

Problem: The fireplace goes through the start-up cycle, but then turns off.

Solution:

- Restart the fireplace. After going through the start-up cycle, select Manual and set the flame height to high for about 5 minutes.
or:
- Place the remote control further away from the fireplace.

or:

- Replace the batteries in the remote control.

Cause: After going through the start-up cycle, the fireplace automatically goes to the last selected settings:

In the case of the thermostat, comfort+ and possibly Moods function, the desired final temperature may have been reached. Possibly the remote control is too close to the fireplace or another heat source.

If the batteries are empty, temperature detection cannot take place and temperature-related functions (comfort+, thermostat, possibly Moods) will not work. The fireplace falls out.

7.2 Product card – part 1 (in conformance with (EU) 2015/1186 Appendix IV)

Model	Gas type	Energy efficiency class*	Nominal heat output (kW)	Minimum heat output (kW)	Energy efficiency index (EEI)	Useful return at nominal heat output (%)	Useful return at minimum heat output (%)	NOx-value (mg/kWh)
Kalfire Gi75/59F Kalfire Gi80/55C Kalfire Gi85/55S	G25.3	B	7,7	2,4	84,4	86,3	81,4	78
	G20	B	7,4	2,9	83,8	85,7	81,5	80
	G30–30 mbar	C	7,3	2,3	80	82	77,1	73
	G30–50 mbar	C	7,3	2,3	80	82	77,1	73
	G31 37mbar	C	6,4	1,6	79	81,2	70,5	77
Kalfire Gi105/59F Kalfire Gi105/79F Kalfire Gi110/55C Kalfire Gi110/75C Kalfire Gi115/55S Kalfire Gi115/75S	G25.3	B	7,4	2,2	86,6	88,5	84,5	69
	G20	B	7,5	2,4	86	87,9	84,5	69
	G30–30 mbar	B	8,0	1,8	85,5	87,3	83,1	72
	G30–50 mbar	B	8,0	1,8	85,5	87,3	83,1	72
	G31 37mbar	B	8	1,8	85,5	87,3	83,1	65

*the values in this table are inspection values in line with EN613, measured with a long configuration.

7.3 Product card – part 2 (in conformance with (EU) 2015/1186 Appendix IV)

Type of heat output/room temperature control	
single stage heat output, no room temperature control	no
two or more manual stages, no room temperature control	no
with mechanic thermostat room temperature control	no
with electronic room temperature control	yes
with electronic room temperature control plus day timer	no
with electronic room temperature control plus week timer	no
Other control options	
room temperature control, with presence detection	no
room temperature control, with open window detection	no
with distance control option	yes
with adaptive start control	no
with working time limitation	no
with black bulb sensor	no
Indirect heating functionality	
	no
Pilot flame power requirement	
	N.A.

Electricity consumption

	Consumption in standby mode (kWh)	Consumption at minimum heat output (kWh)	Consumption at nominal heat output (kWh)
Fireplace turned off	0,0053	-	-
Fireplace turned off -EmberGlow on	0,0175	-	-
Fireplace turned on	-	0,0348	0,0388
Fireplace turned on -EmberGlow on	-	0,049	0,051
Fireplace turned on -NSG on	-	0,0368	0,0433
Fireplace turned on -EmberGlow on -NSG on	-	0,0547	0,0567

NB: The electricity consumption is the same for all Kalfire Gi models.

7.4 Declaration of conformity

Kalfire B.V.
Geloërveldweg 21
NL - 5951 DH, Belfeld

Declares, that this declaration of conformity is issued under our full responsibility they belong to the models below.

Product: local gas fire according to the convection principle

Type: C11,C31, C91

Product name: Kalfire

Kalfire Gi75/59F, Gi80/55C, Gi85/55S

Kalfire Gi105/59F, Gi110/55C, Gi115/55S,

Kalfire Gi105/79F, Gi110/75C, Gi115/75S

This declaration of conformity complies with the Harmonisation legislation of the Union:

- Directive 2009/142/EC, Regulation (EU) 2016/426 (of 21 April 2018)
- Directive 2009/125/EC, Regulation (EU) 2015/1188 (of 28 April 2015)
- Directive 2010/30/EU, Regulation (EU) 2015/1186 (of 24 April 2015)

Applied standards or other technical specifications covered by the declaration of conformity:

NEN-EN 613 (2021)

NEN-EN 437 (2021)

Testing body:

Certigaz

Rue du Général Leclerc CS-60264

92047 PARIS LA DEFENSE CEDEX

France

Date: 1-12-2023

Drs Ing Beijko van Melick Msc



General Director

Kalfire BV

7.5 Configuration of the decorative elements

7.5.1 Placing the decorative elements

Kalfire Gi75/59F, Gi80/55C, Gi85/55S



CAREFUL!

The decorative elements must be placed according to the instructions. It is prohibited to alter the number of decorative elements or the configuration thereof. Such alterations can lead to hazardous situations with regard to fire safety.



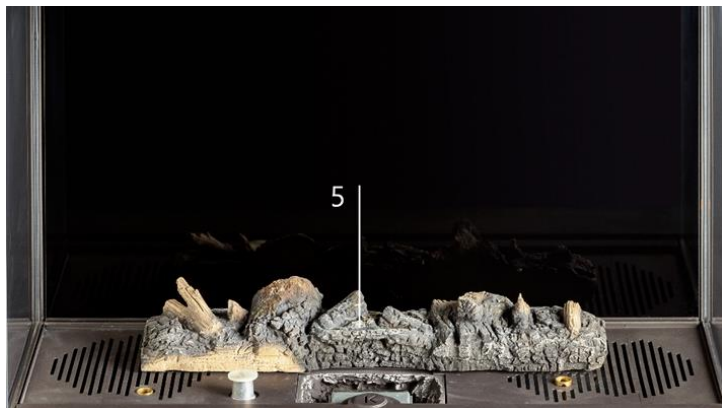

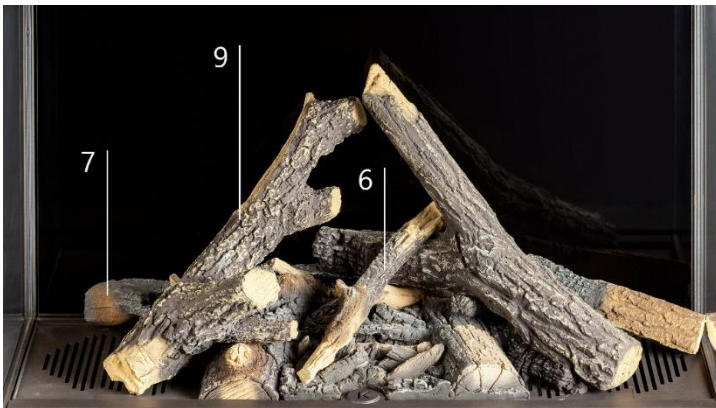



7.5.2 Placing the decorative elements

Kalfire Gi105/59F, Gi110/55C, Gi115/55S, Gi105/79F, Gi110/75C, Gi115/75S



CAREFUL!

The decorative elements must be placed according to the instructions. It is prohibited to alter the number of decorative elements or the configuration thereof. Such alterations can lead to hazardous situations with regard to fire safety.

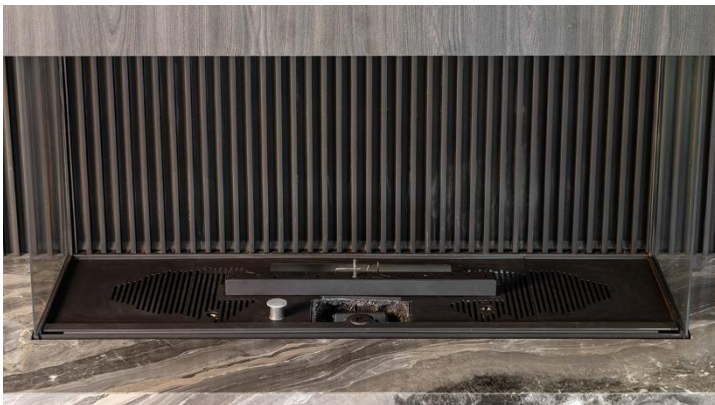





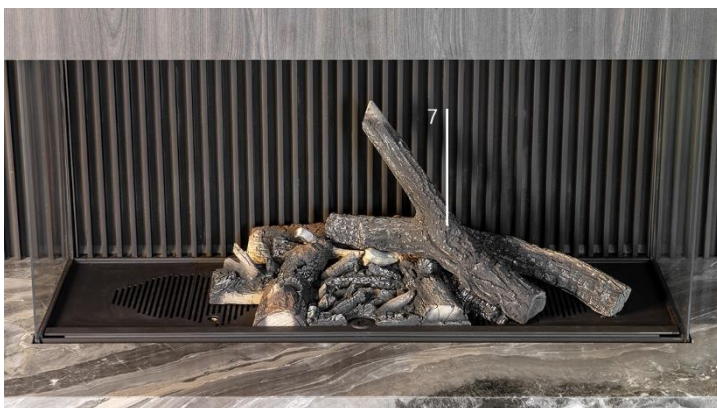

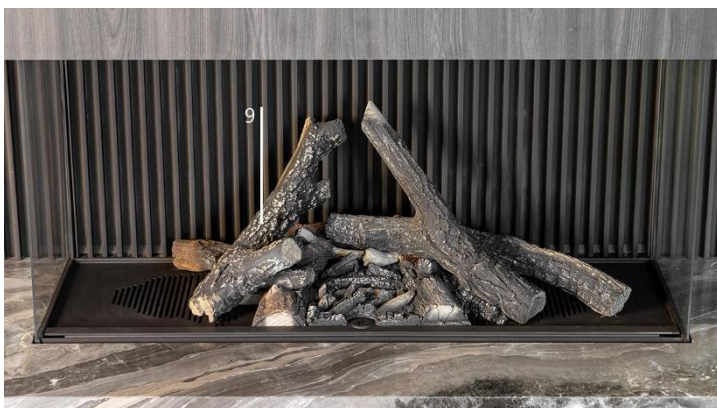



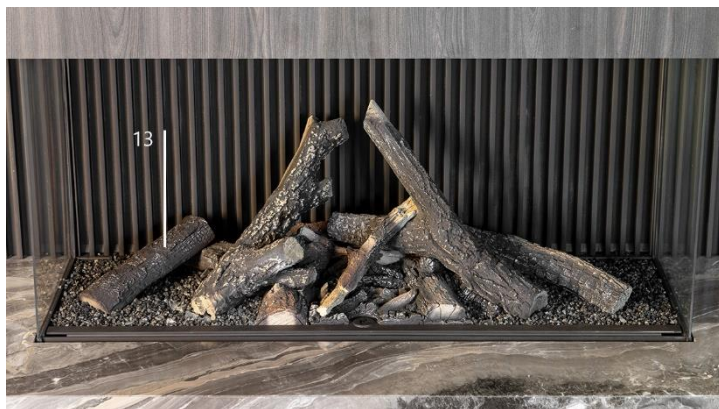

KALFIRE

FIREPLACES

Geloërveldweg 21
5951 DH Belfeld
info@kalfire.com
KALFIRE.COM